

LINEAR FIXTURE TRACK - PANEL SPEC SHEET



LFT60-P



The LFT60-P Series is a collection of diffused linear fixture panels with exceptional lighting performance for any setting. With its wide range of track mounting options, the LFT60-P is compatible with recessed, surface and suspended pendant mounting. The series is equipped with dimming and standard color temperature of 3000K. The LFT60-P7 is an inverted L shaped diffused panel light with a power rating of 9 Watts.



LFT60-P7

SPECIFICATIONS

OPERATING VOLTAGE	120 VAC
RATED POWER	9W
CONTROL	0/1-10 V Dimmable
FLUX	388 lm
CRI	>90
BODY FINISH	Black, White
MOUNTING	Track mounted
PROJECTION	100°

- V** 120 VAC
Operating Voltage
- W** 9W
Rated Power

DIMENSIONS

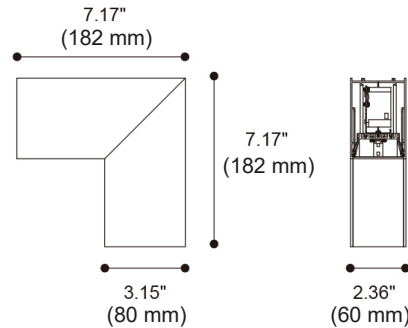

ORDERING CODE

SERIES	TYPE	POWER	VOLTAGE	CRI	COLOR TEMPERATURE	PROJECTION	TRACK MOUNTING	BODY FINISH
LFT60	P7 - Panel 7	9W - 9 WATTS	AC - 120VAC	90 - CRI90	CT30 - 3000K CTXX - CUSTOM	100D - 100 Degrees	RM - Recessed Mount SM - Surface Mount PM - Pendant Mount	BK - Black WH - White

Sample: LFT 60-P7 - 9W - AC - 90 - CT30 - 100D - SM - BK

LINEAR FIXTURE TRACK - MOUNTING & ACCESSORIES



LFT60-P

MOUNTING OPTIONS

TRIMLESS: LFT-T-11

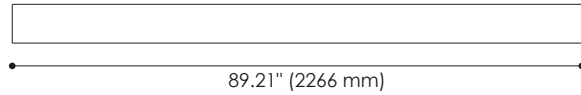
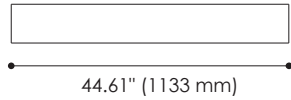
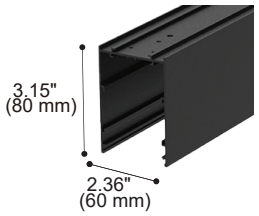

TRIMLESS TRACK SECTION	
Article number	TYPE
LFT-T-11-44	Channel
LFT-T-11-89	Channel

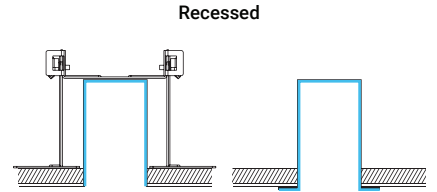

TRIM: LFT-F-11

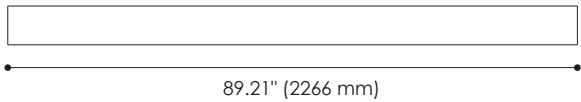
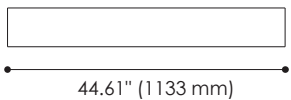
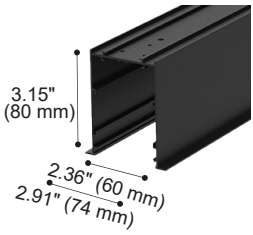

TRIMMED TRACK SECTION	
Article number	TYPE
LFT-F-11-44	Channel
LFT-F-11-89	Channel

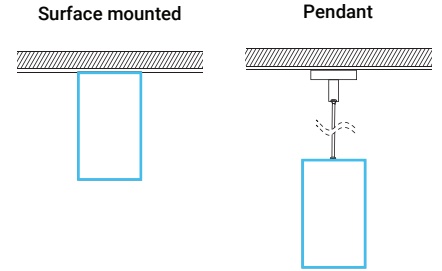

ACCESSORIES

ALL MODELS

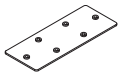
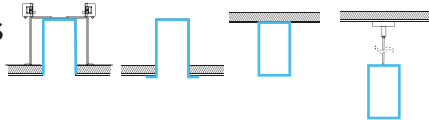

3PCS

SKU : LFT-NC-02
Type : Surface mounted & Pendant reinforced plate

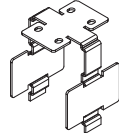

SKU : LFT-NC-07
Type : Light Leak-proof aluminium extrusion reinforce plate



Colours
Black White

SKU :
LFT-NE-02-11 11.14" (283 mm)
LFT-NE-02-22 22.28" (566 mm)
Type : Blank cover



SKU : LFT-SA-41
Type : Power cord connector



SKU : LFT-PA-41-180
71" (1800 mm)
Type : Power cord connect to AC



SKU : LFT-SA-41-30 12" (300 mm)
LFT-SA-41-60 24" (600 mm)
Type : Power cord connect between modules

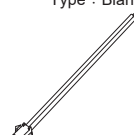

SKU : LFT-PSA-31-180 71" (1800 mm)
Type : Signal wire connect to system / dimmer

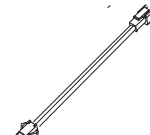

SKU : LFT-SSA-31-30 12" (300 mm)
LFT-SSA-31-60 24" (600 mm)
Type : Signal wire connect between modules

PENDANT

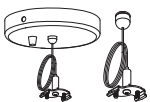
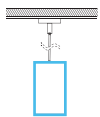

SKU : LFT-DI-15
Type : Pendant Kit for power connection (without power cord)

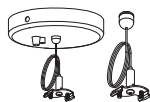

SKU : LFT-DI-15-V
Type : Pendant Kit for power connection (without power cord and single wire)



SKU : LFT-DI-16
Type : Pendant kit

TRIM

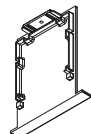
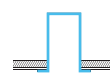

2PCS

SKU : LFT-NC-05
Type : Trim end cap

TRIMLESS

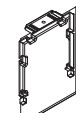
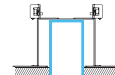

2PCS

SKU : LFT-NC-03
Type : End cap

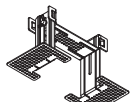

2PCS

SKU : LFT-NR-01
Type : Trimless bracket