

OAK SQUARE SMALL AC SPEC SHEET



OAK-Q-S-AC



Our OAK series LED spotlight fixtures are a simple, yet elegant solution for architectural spot and accent luminaire. Available with three optic configurations (Narrow, Medium & Wide). The luminaire is capable of withstanding extreme outdoor conditions with a chemically sealed glass lens and proprietary moisture barriers.

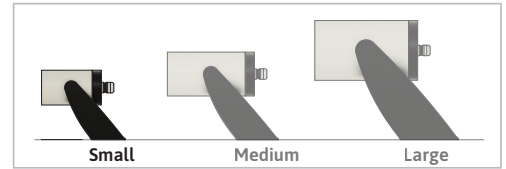

SPECIFICATION

OPERATING VOLTAGE	100 - 240 VAC
OPERATING TEMPERATURE	-20°C to + 50°C
CRI	80
INPUT CURRENT @115 VAC, 60Hz	90 mA
INPUT CURRENT @230 VAC, 50Hz	55 mA
NO OF LED	1
LED TYPE	SMD
LIGHT SOURCE	Samsung
COLOR RANGE	2700K / 3000K / 3500K / 4000K
PROJECTION	Narrow, Medium, Wide
FIXTURE CONNECTION	Pigtail
AVAILABLE IP RATING	IP66

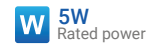

DELIVERED LUMENS BY CCT

White	Lumens (5W)
2700K	310 lm
3000K	310 lm
3500K	310 lm
4000K	310 lm

Application

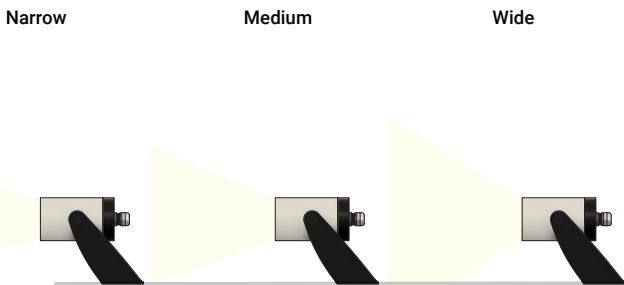
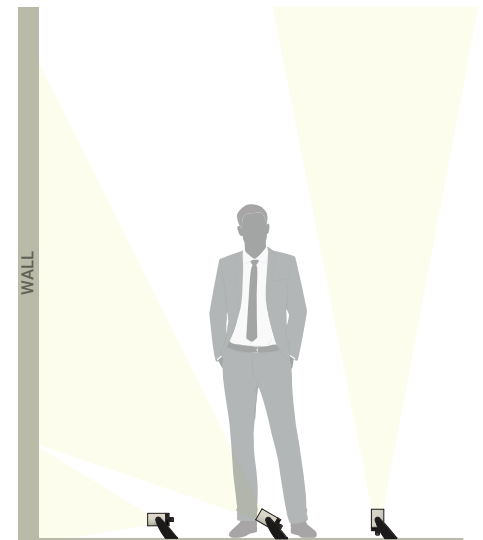

180° Angle Swivel Base

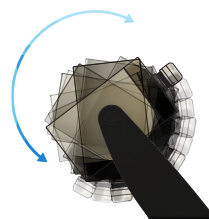

Honeycomb Louver (Optional)



OAK SQUARE SMALL AC SPEC SHEET

OAK-Q-S-AC



ORDERING CODE

PRODUCT SERIES	TYPE	SIZE	POWER	COLOR TEMPERATURE	PROJECTION	MOUNTING	VOLTAGE	ACCESSORIES
OAK	Q - SQUARE	S - SMALL	3W - 3WATTS 5W - 5WATTS	CT 27 - 2700K CT 30 - 3000K CT 35 - 3500K CT 40 - 4000K	NB - NARROW MB - MEDIUM WB - WIDE	SM - SURFACE MOUNT SP - SPIKE MOUNT	DC - 100-240VDC	N - NONE H - HONEYCOMB

FITURE FINISHING	
BODY FINISH	TRIM FINISH
BWH - WHITE	TWH - WHITE
BBL - BLACK	TBL - BLACK
BSL - SILVER	TSL - SILVER
BCM - CUSTOM	TGL - GOLD
	TCM - CUSTOM

Sample: OAK-Q-S-5W-CT27-NB-SM-AC-H-BWH-TBL

DIMENSIONS

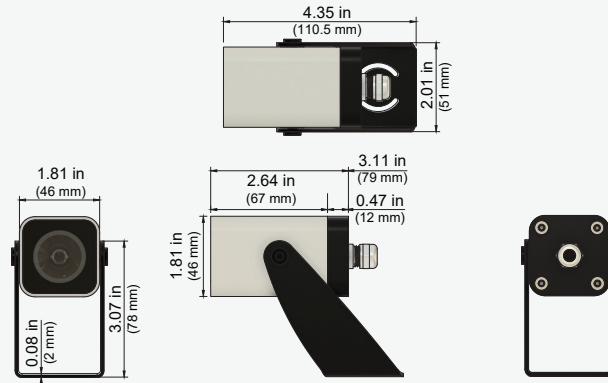

PHOTOMETRIC DATA

Polar Curve

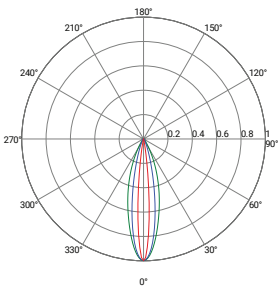

BIN Details (CIE 1931)

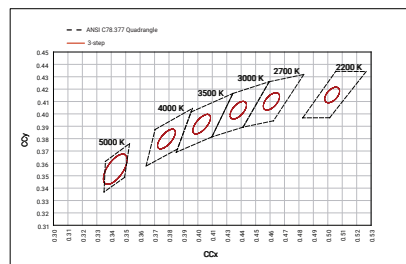

Spectral Radiant Flux VS Wavelength

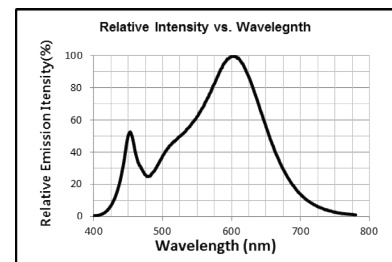

RELATED PRODUCTS

Spike Mount



OAK - Square Small - DC

