

WALLWASHER LRO SERIES INSTALLATION

LRO-36

IP67
WATER
PROOF



INSTALLATION

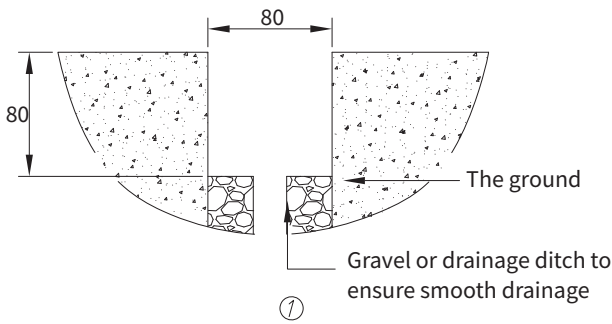

1. Grooves no smaller than the size indicated in the drawing should be reserved at the designated position. There must be a drainage tank or other drainage structure at the bottom of the tank to ensure smooth drainage.

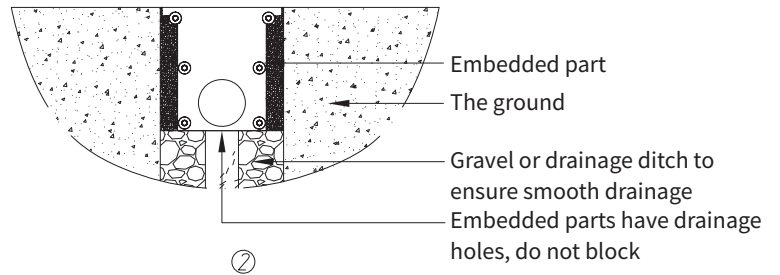

2. Place the embedded parts, connect the wiring pipe, and arrange the corresponding lines (signal lines and power lines). The surrounding of the embedded parts is fixed with cement mortar. If the surrounding areas are flat and firm, screws can be selected to fix according to the actual situation

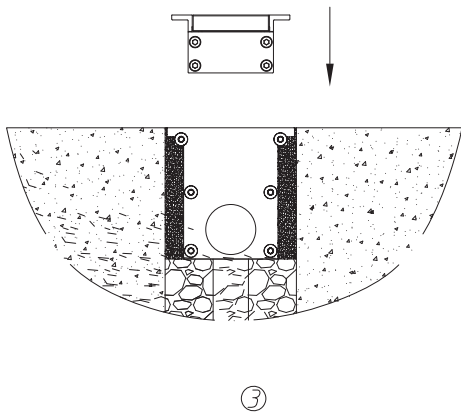

3. Start laying the circuit, connect the blue and brown lights to the negative and positive terminals of the power supply respectively. The connection box of IP68 protection grade is used, and the plug of both male and female IP67 should be wrapped with high pressure waterproof tape. Or take other protective measures up to IP68. After confirming the connection of the lamp, try to switch on the power supply and check whether the lamp lights up normally.

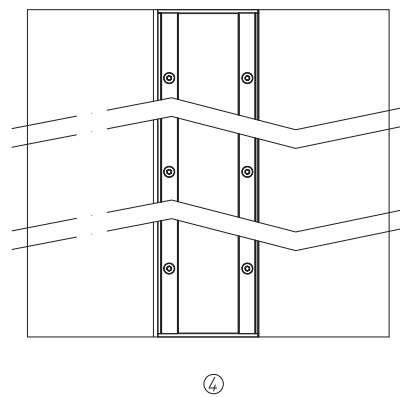

4. Confirm that lamp are worked first, and then disconnect the power, put the lamp into the embedded parts, and then fix the lamp on the embedded box with the inner hexagon cylindrical head machine wire, power on again, finally confirm if the lamp are worked again